

Switch, Pin Diode, Single Pole Five Throw 0.5-20GHz Module,

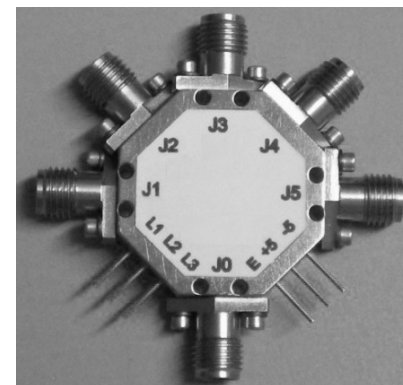
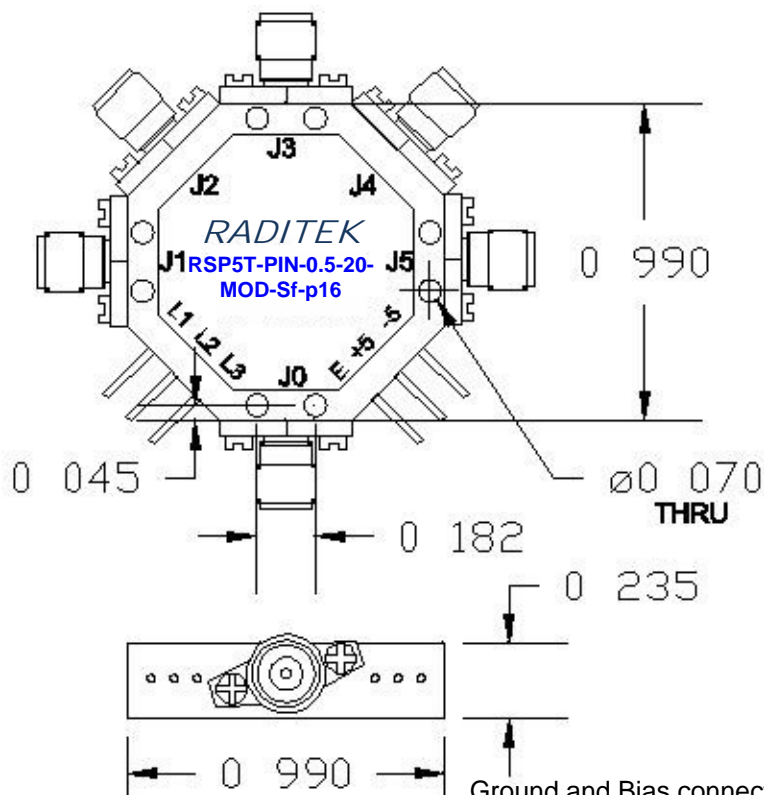

Truth Table

L1	L2	L3	E	J1	J2	J3	J4	J5
L	L	L	H	IL	ISO	ISO	ISO	ISO
H	L	L	H	ISO	IL	ISO	ISO	ISO
L	H	L	H	ISO	ISO	IL	ISO	ISO
H	H	L	H	ISO	ISO	ISO	IL	ISO
L	L	H	H	ISO	ISO	ISO	ISO	IL
X	X	X	L	ISO	ISO	ISO	ISO	ISO

Applications

- Military Radar, Radio and ECM
- Test Instrumentation
- Telecom Infrastructure
- Microwave Radio & VSAT

Units: Inch
Not to scale

Ground and Bias connector - solder pins
Material Connector: Passivated stainless steel
Material Contacts: Gold plated BeCu
Connector: Removable SMA(F) X 6
Mounting holes DIA 70 mil X 6 places
Plating: Electroless Nickel

Order Examples: RSP5T-PIN-0.5-20-MOD -p16

Description: Switch, Single Pole Five Throw, Pin Diode, 0.5-20GHz, module,)

Specifications:		Units
Frequency Range	0.5-20	GHz
Insertion loss	3.2	dB max
Isolation	60	dB min
VSWR	1.8 :1	
Switching Speed	30	nsec typ
Impedance	50	
Bias Voltage	+5 @ 40mA -5 @ 40mA	V
Connectors	Removable SMA Female x6	
Operating Temperature	-40 to +85	°C
Storage Temperature	-55 to +85	°C

Switch, Pin Diode, Single Pole Five Throw 0.5-20GHz Module,

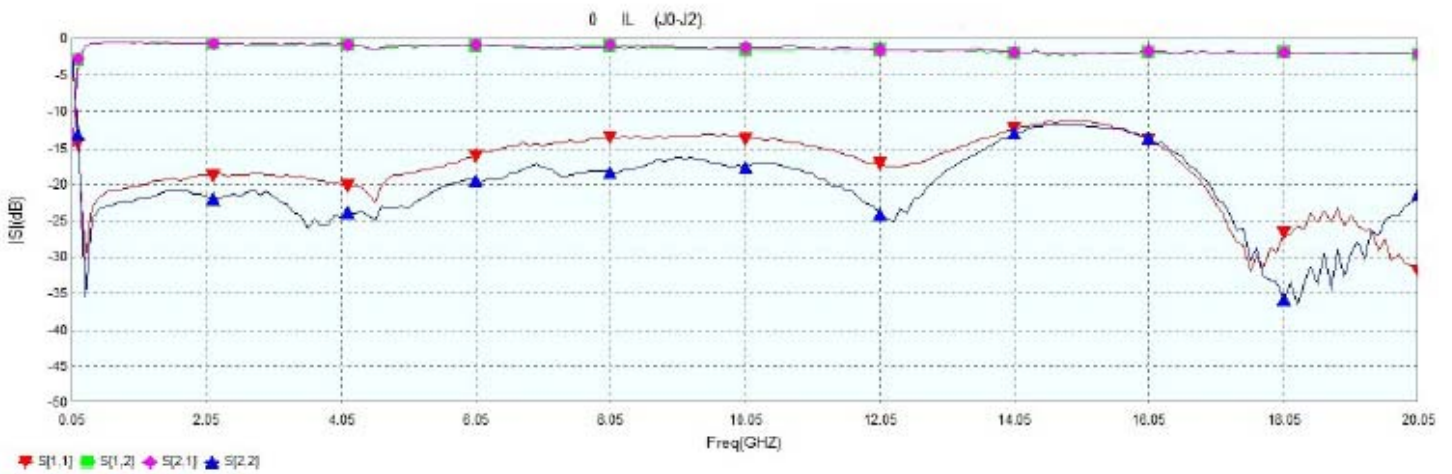
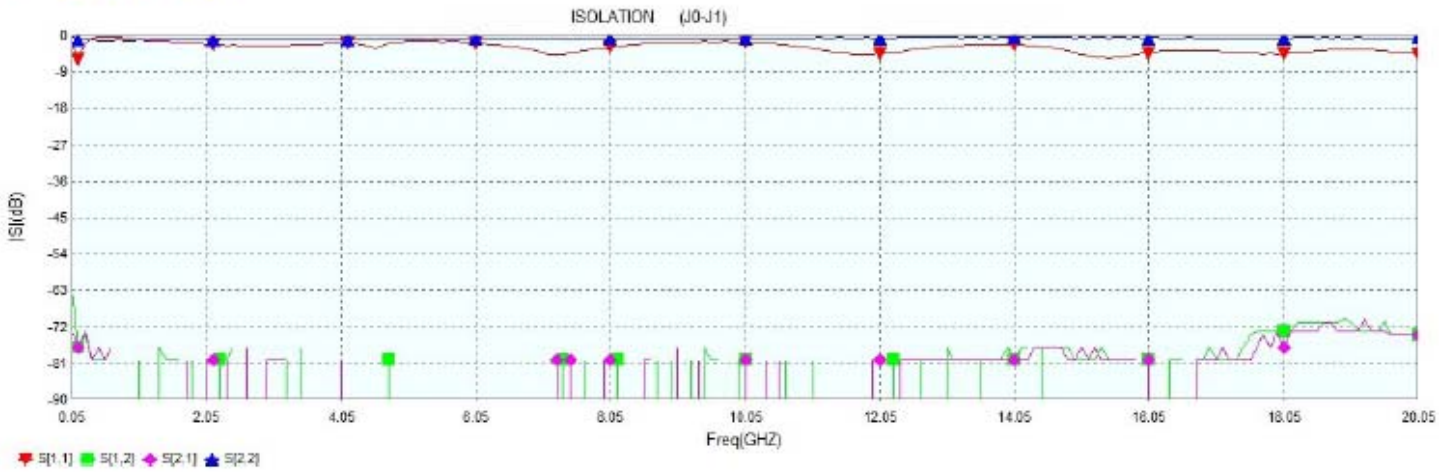
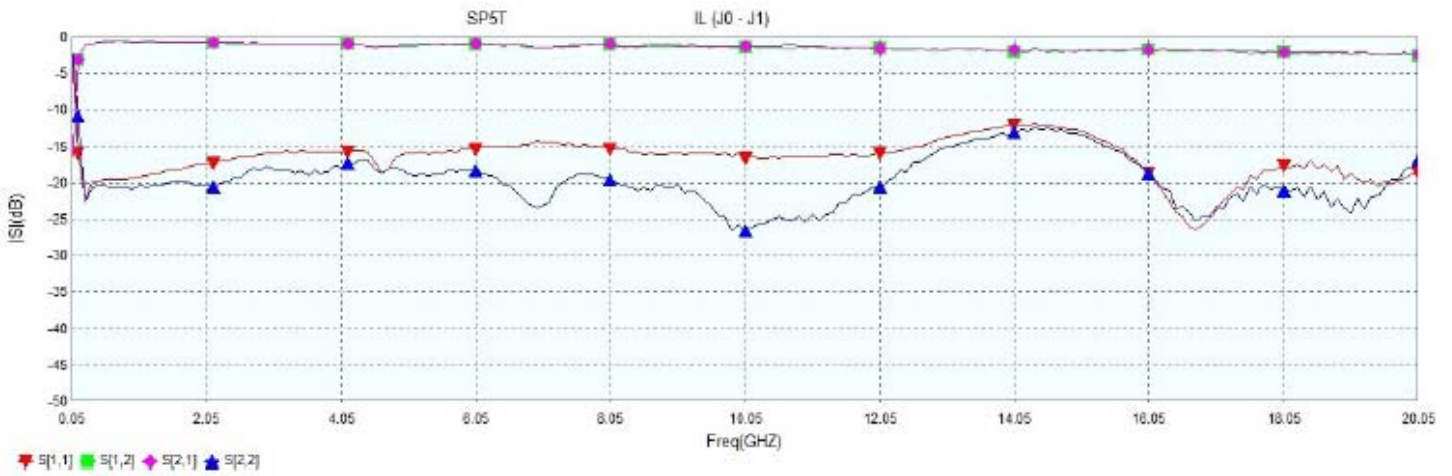

Switch, Pin Diode, Single Pole Five Throw 0.5-20GHz Module,

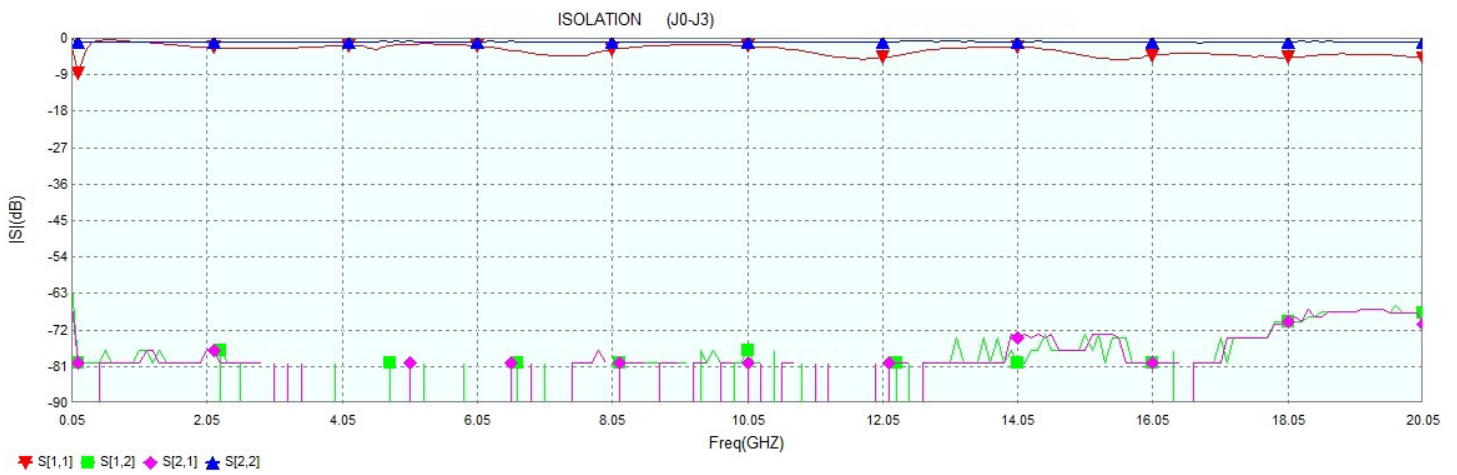
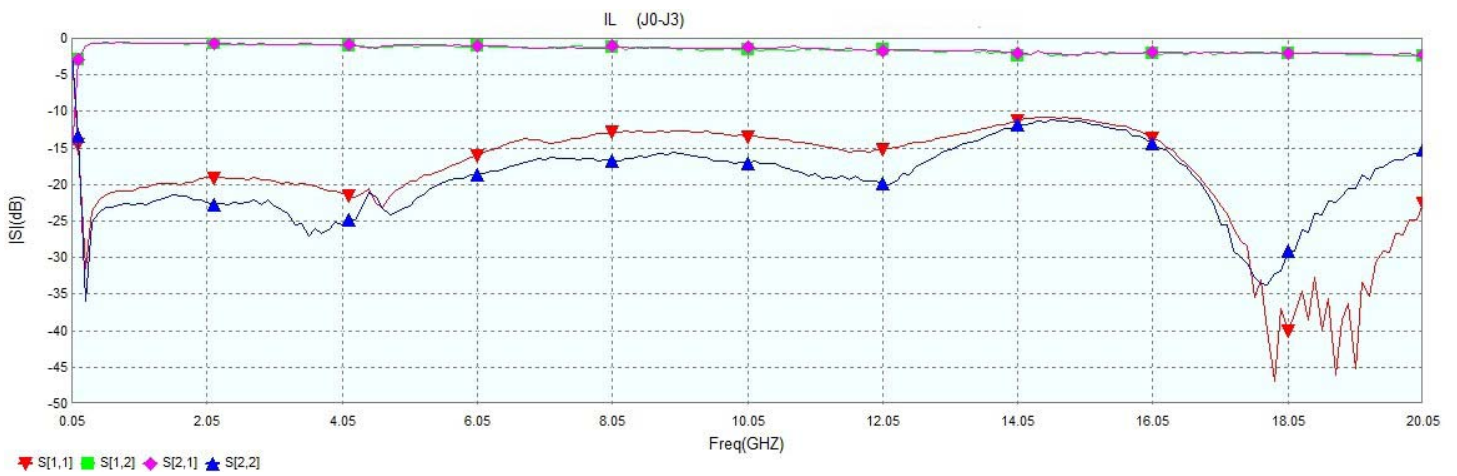
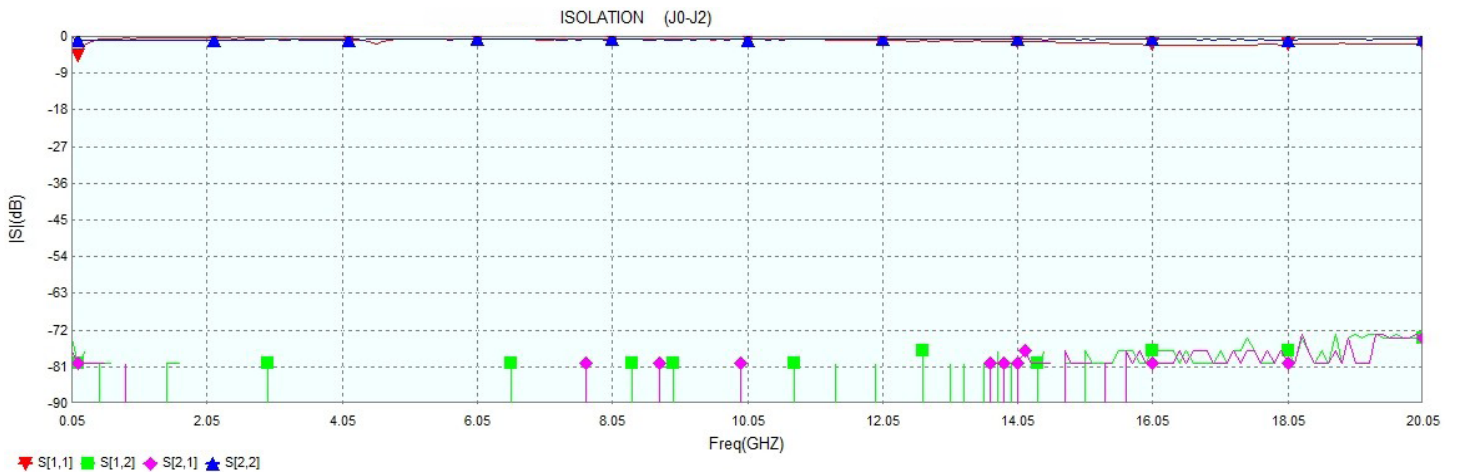

Switch, Pin Diode, Single Pole Five Throw 0.5-20GHz Module,

